



[首页](#)

[公司介绍](#)

[产品](#)

[新闻中心](#)

[视频中心](#)

[联系我们](#)

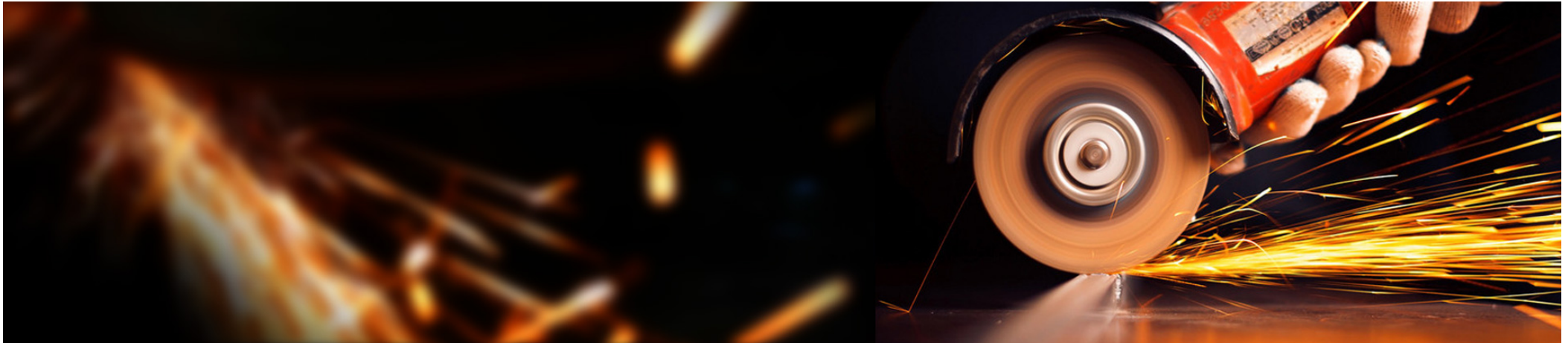

[首页](#) > [产品](#) > [PZ533](#)

# PZ533

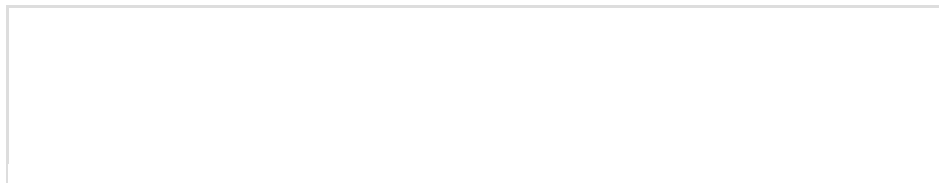

PZ533

磨床



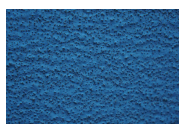
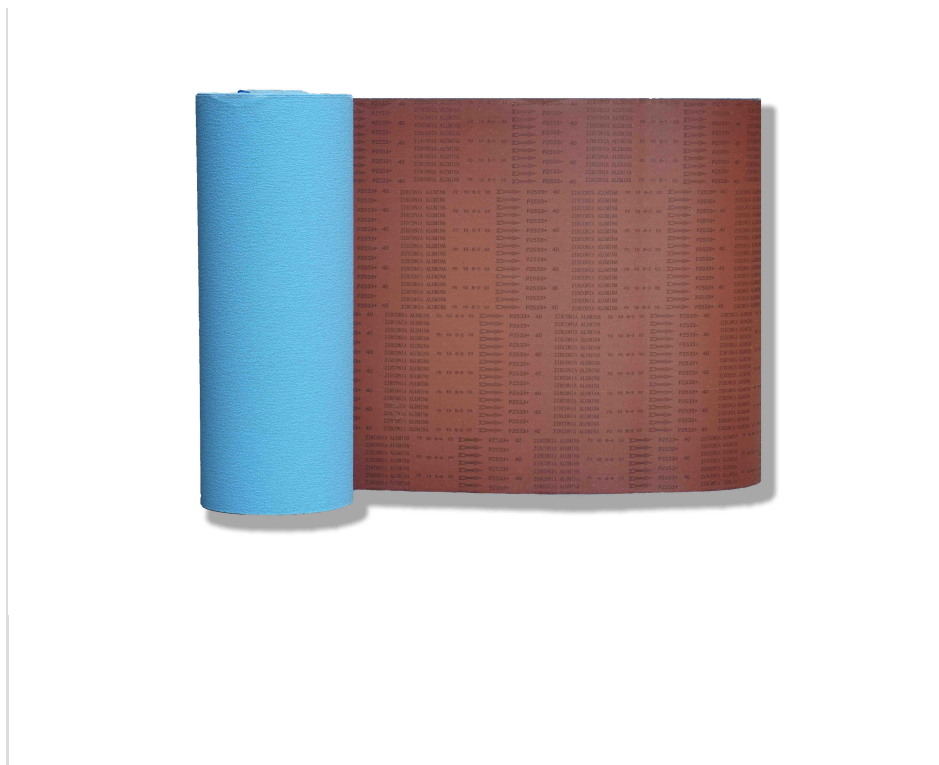

## 粒度

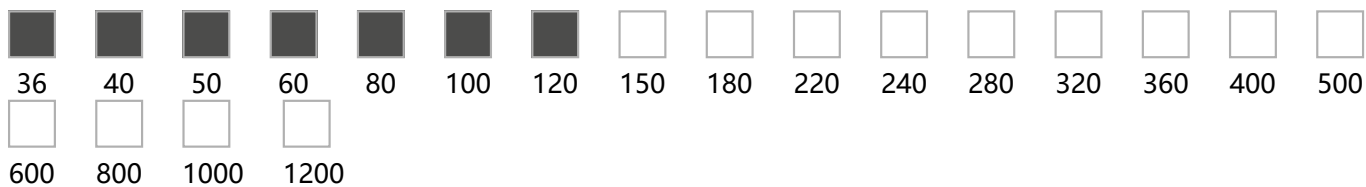

## 产品参数

**颗粒类型** 特殊涂层  
刚玉

**背基** 混纺布

**颜色** 蓝色

**植砂密度** 密植砂

**柔韧度** 硬布

**粘接剂** 全树脂

**大卷宽幅** 1.38M

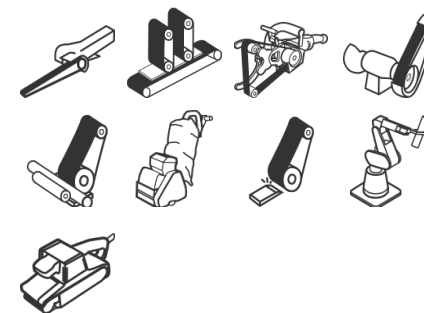

## 材料

材料用途:



## 信息材料

点击下载文件:



## 优点

---

- 高抗拉伸和非常稳定的背衬材料
- 添加免烧处理
- 用于高接触压力的打磨
- 钛/可锻铸铁/转子和叶片 | 喷气式叶片
- 低碳钢 | 高钴 | 镍合金 | SUS300 (不锈钢)
- 重型去毛刺
- 锻造金属去毛刺
- 220#可定制

→ [公司介绍](#)

→ [产品](#)

→ [新闻中心](#)

## 联系我们

### 河南金太阳科技有限公司

 地址：开封市杏花营镇十大街与陇海二路交叉口路北

 电话：0371-22110389

 传真：0371-22110389

 邮件：  
cliu@chinagoldensun.cn

 WeChat



[→ 版本说明](#) [→ 隐私政策](#)

版权所有 © 河南金太阳科技有限公司2022

